

OMNISTAR



Designed to generate massive savings and bring benefits to area and tunnel lighting

OMNISTAR is setting a new standard by providing a performing LED alternative to HID luminaires for high-mast, high bay, tunnel and other high-power applications with a minimum total cost of ownership.

This luminaire has been designed to provide an unrivalled combination of performance and flexibility for lighting areas where high lumen packages are needed with the added advantages of an LED solution: low energy consumption, improved visibility with white light, limited maintenance and longer life.

In addition to maximising energy savings, the OMNISTAR is a connected-ready lighting solution to meet your future smart city or tunnel requirements.

OMNISTAR can be installed in various configurations (suspended, surface-mounted or post-top) with one to three optical units.



Concept

OMNISTAR provides a complete solution for applications requiring high lumen packages. It is composed of an optical unit (up to 240 high-power LEDs), a remote gear box, cables with quick connectors and various mounting systems.

OMNISTAR combines the energy efficiency of LED technology with the performance of the photometric concepts developed by Schröder. The design of the LensoFlex® photometric engines and the flexibility of the photometric distributions ensure safe and pleasant conditions for users while offering superior efficacy.

OMNISTAR can be also be fitted with reflectors to provide a counter beam lighting solution (ReFlexo™ photometries) for sports, tunnel and apron applications.

Dedicated collimator optics (BlastFlex™) and louvres are also available to deliver the requested beams for specific sport and architectural lighting applications.

Composed of robust materials, OMNISTAR is highly resistant to shocks and corrosion in harsh environments. As an option, an explosion proof version is available to meet specific industrial requirements.

OMNISTAR offers a modular concept of optical units which enables 1, 2 or 3 modules to be grouped on the same bracket to meet the specifications of the area to be lit. On-site adjustment guarantees the perfect lighting.

A separate driver box can be easily plugged in to an LED optical unit with quick connectors to facilitate both installation and maintenance operations. This also means that the OMNISTAR will be able to take advantage of future technological developments.



OMNISTAR is delivered with quick connectors for an easy installation.



The OMNIBOX and OMNIBOX XL are IP 66 driver boxes that can be easily connected to one or more OMNISTAR luminaires for easy installation and maximum flexibility.

TYPES OF APPLICATION

- ACCENT & ARCHITECTURAL
- TUNNELS & UNDERPASSES
- CAR PARKS
- LARGE AREAS
- INDUSTRIAL HALLS & WAREHOUSES
- ROADS & MOTORWAYS
- SPORT FACILITIES

KEY ADVANTAGES

- Real beneficial LED alternative to HID floodlights for high-power applications
- Cost-effective and efficient to maximise energy and maintenance savings
- Flexibility: modular approach with wide range of lighting distributions
- Easy to dim: can adapt to the different lighting regimes required
- Highly efficient light distributions reduce the quantity of luminaires to be installed
- Various mounting options and inclination possibilities on-site for optimal photometry
- Explosion proof variant for use in industrial environments with a hazardous atmosphere
- Compact size: for tunnels with restrictive heights and to avoid any damage
- Various control options including remote management systems

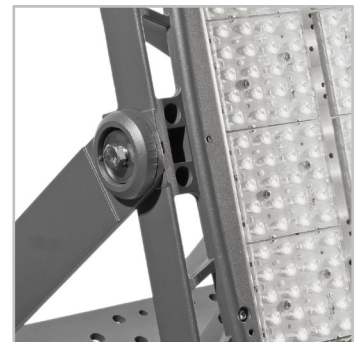

The inclination angle can be easily adjusted on-site.



With up to 240 high-power LEDs, OMNISTAR delivers high lumen packages.

OMNISTAR | standard U bracket



OMNISTAR | large U bracket (wall mounting)



OMNISTAR | large U bracket (pole mounting)



OMNISTAR | tiltable ceiling mounting



OMNISTAR | fixed ceiling mounting



OMNISTAR | suspended with chains



OMNISTAR | 2 optical units, tiltable together



OMNISTAR | 2 optical units, tiltable independently



OMNISTAR | 3 optical units, tiltable together





Control light spill

As an option, the luminaire can be equipped with louvres to minimise light spill and prevent intrusive lighting. They can be fitted inside or outside the optical unit, depending on the desired direction of the light distribution.

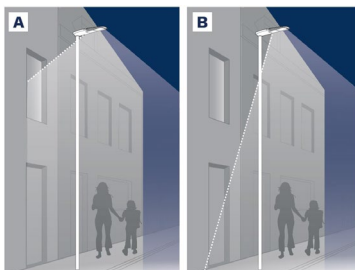

A. Without louvres
B. With louvres



LensoFlex®2

LensoFlex®2 is based upon the addition principle of photometric distribution. Each LED is associated with a specific PMMA lens that generates the complete photometric distribution of the luminaire. The number of LEDs in combination with the driving current determines the intensity level of the light distribution.



LensoFlex®3

LensoFlex®3 uses lenses made of mouldable and optical-grade silicon offering superior transparency and excellent photothermal stability. This withstands high driving currents and delivers maximised lumen output over time. As silicon offers a higher thermal resistance compared to PMMA, temperature is not as critical for LensoFlex®3 engines. This offers two distinct advantages; LensoFlex®3 ensures enhanced performance in warm climates and enables a high driving current to be used to increase the lumen output and a higher lm/kg ratio. It also does not suffer from yellowing over time.



LensoFlex®4

LensoFlex®4 maximises the heritage of the LensoFlex® concept with a very compact yet powerful photometric engine based upon the addition principle of photometric distribution. The number of LEDs in combination with the driving current determines the intensity level of the light distribution. With optimised light distributions and very high efficiency, this fourth generation enables the products to be downsized to meet application requirements with an optimised solution in terms of investment.

LensoFlex®4 optics can feature backlight control to prevent intrusive lighting, or a glare limiter for high visual comfort.

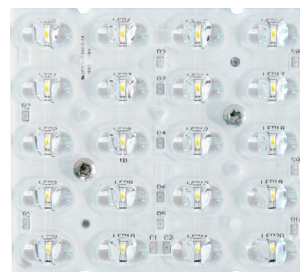



ReFlexo™

Using metal reflectors with a superior reflective co-efficient, the ReFlexo™ photometric engine delivers high performance for specific applications such as counter beam lighting in tunnels or very extensive light distributions for sports or apron lighting.

Another key advantage of the ReFlexo™ is its' ability to direct all the light to the front of the luminaire, ensuring that no back light is emitted. This photometric engine guarantees glare free lighting for excellent visual comfort and the creation of ambiance.



BlastFlex™

Using silicon collimators, the BlastFlex™ photometric engine offers the highest efficacy for directional beams dedicated to specific applications in architectural and sports lighting. The ability to control the light with the highest accuracy reduces the light spill in the surroundings and contributes to an optimal use of the energy consumed. Thanks to a superior thermal resistance, the BlastFlex™ optics can work with very high currents to provide large lumen packages and do not suffer from the yellowing effect over time.



BlastFlex™4

Using collimators made of high-transmission PMMA, the BlastFlex™4 photometric engine offers the highest efficiency for directional beams dedicated to specific applications in architectural and sports lighting. The ability to control the light with the highest accuracy reduces light spill in the surroundings, improves uniformity on the area to be lit and contributes to optimal use of the energy consumed.

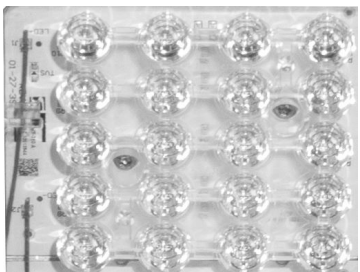



Constant Light Output (CLO)

This system compensates for the depreciation of luminous flux to avoid excess lighting at the beginning of the installation's service life. Luminous depreciation over time must be taken into account to ensure a predefined lighting level during the luminaire's useful life.

Without a CLO feature, this simply means increasing the initial power upon installation in order to make up for luminous depreciation. By precisely controlling the luminous flux, the energy needed to reach the required level can be maintained throughout the luminaire's life.

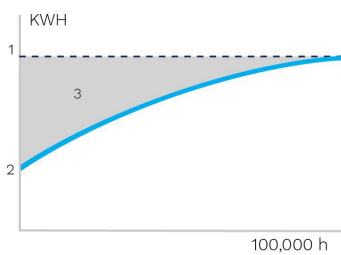

1. Standard lighting level | 2. LED lighting consumption with CLO | 3. Energy savings



Custom dimming profile

Intelligent luminaire drivers can be programmed with complex dimming profiles. Up to five combinations of time intervals and light levels are possible. This feature does not require any extra wiring.

The period between switching on and switching off is used to activate the preset dimming profile. The customised dimming system generates maximum energy savings while respecting the required lighting levels and uniformity throughout the night.

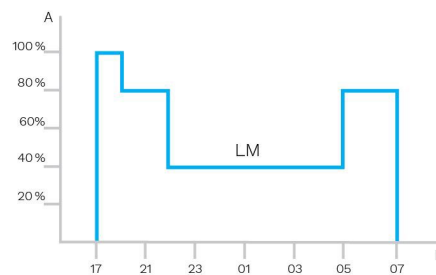

A. Dimming level | B. Time

Schröder EXEDRA is the most advanced lighting management system on the market for controlling, monitoring and analysing streetlights in a user-friendly way.



Standardisation for interoperable ecosystems

Schröder plays a key role in driving standardisation with alliances and partners such as uCIFI, TALQ or Zhaga. Our joint commitment is to provide solutions designed for vertical and horizontal IoT integration. From the body (hardware) to the language (data model) and the intelligence (algorithms), the complete Schröder EXEDRA system relies on shared and open technologies. Schröder EXEDRA also relies on Microsoft™ Azure for cloud services, provided with the highest levels of trust, transparency, standards conformance and regulatory compliance.

Breaking the silos

With EXEDRA, Schröder has taken a technology-agnostic approach: we rely on open standards and protocols to design an architecture able to interact seamlessly with third-party software and hardware solutions. Schröder EXEDRA is designed to unlock complete interoperability, as it offers the ability to:

- control devices (luminaires) from other brands
- manage controllers and to integrate sensors from other brands
- connect with third-party devices and platforms

A plug-and-play solution

As a gateway-less system using the cellular network, an intelligent automated commissioning process recognises, verifies and retrieves luminaire data into the user interface. The self-healing mesh between luminaire controllers enables real-time adaptive lighting to be configured directly via the user interface. OWLET IV luminaire controllers, optimised for Schröder EXEDRA, operate Schröder's luminaires and luminaires from third parties. They use both cellular and mesh radio networks, optimising geographical coverage and redundancy for continuous operation.

Tailored experience

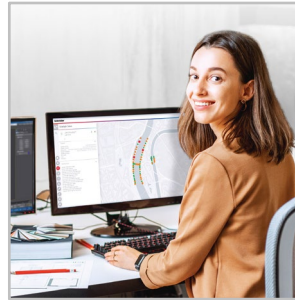

Schröder EXEDRA includes all advanced features needed for smart device management, real-time and scheduled control, dynamic and automated lighting scenarios, maintenance and field operation planning, energy consumption management and third-party connected hardware integration. It is fully configurable and includes tools for user management and multi-tenant policy that enables contractors, utilities or big cities to segregate projects.

A powerful tool for efficiency, rationalisation and decision making

Data is gold. Schröder EXEDRA brings it with all the clarity managers need to drive decisions. The platform collects massive amounts of data from end devices and, aggregates, analyses and intuitively displays them to help end-users take the right actions.

Protected on every side



Schröder EXEDRA provides state-of-the-art data security with encryption, hashing, tokenisation, and key management practices that protect data across the whole system and its associated services. The whole platform is ISO 27001 certified. It demonstrates that Schröder EXEDRA meets the requirements for establishing, implementing, maintaining and continually improving security management.

Mobile App: any time, any place, connect to your street lighting

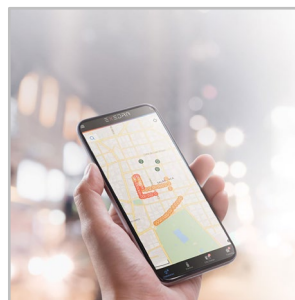

The Schröder EXEDRA mobile application offers the essential functionalities of the desktop platform, to accompany all types of operator on site in their daily effort to maximise the potential of connected lighting. It enables real-time control and settings, and contributes to effective maintenance.

Advanced Tunnel System 4 (ATS 4)

The ATS 4 (Advanced Tunnel System 4) is a powerful tunnel lighting control system for precise remote dimming and switching of each individual connected luminaire, based on various tunnel parameter inputs (emergency exits, smoke extraction system, traffic cameras, etc.).

The ATS 4 permanently communicates with the Lumgates, an RS422 closed-loop device connected to the luminaire drivers, to control the light intensity and provide command/reporting features.



Advanced Tunnel System 4 DALI (ATS 4 DALI)

The Advanced Tunnel System 4 DALI provides the essential functions of the ATS 4 over a DALI network protocol, enabling dimming of luminaire clusters to be controlled collectively.

The ATS 4 DALI is the ideal solution to implement a reliable and powerful tunnel lighting control system with streamlined features and optimised costs.



Sensors and cameras

The ATS 4 can be connected to various sensors and cameras to permanently adjust the lighting levels to indoor and outdoor conditions and avoid any visual adaptation problems.



Tunnel Control System 4 (TCS 4)

The Tunnel Control System 4 (TCS 4) is a gateway ensuring the connection/control of the multiple ATS 4 controllers as well as the communication with the central management system of the tunnel infrastructure (SCADA) if applicable.

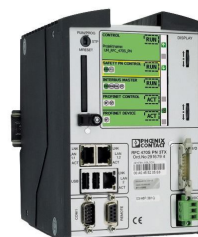

Jointly developed by Schröder and Phoenix Contact, the Advanced Tunnel System 4 (ATS 4) has been designed to control every lighting point or clusters of luminaires to perfectly adapt the lighting level according to conditions in the tunnel, to monitor the power consumption and to report the burning hours or any failure to facilitate maintenance. The system includes a self-commissioning feature and enables scenarios to be adapted remotely at any moment.

ADAPTIVE LIGHTING ACCORDING TO SPEED



The ATS 4 can be linked to a traffic monitoring system to obtain data regarding speed or density to adapt the lighting level according to safety standards. This option further reduces energy consumption and increases the lifetime of the installation while ensuring the best driving conditions for motorists.

PRECISE AND CONTINUOUS DIMMING

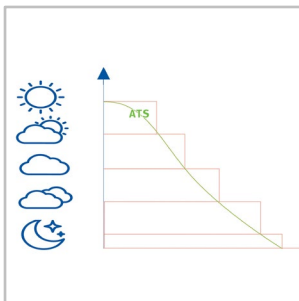

ATS 4 provides 25 different dimming levels to precisely adapt the lighting to the real needs. Without any over-lighting, the energy consumption is limited to what is absolutely necessary to ensure safe and comfortable driving conditions.

ADAPTIVE LIGHTING ACCORDING TO POLLUTION

Based on cleaning cycles, the ATS 4 can take into account the depreciation of the flux due to dirt accumulation to continuously provide the requested lighting level in the tunnel. No more, no less. This feature offers additional energy savings while providing safety and comfort for users.

FLEXIBILITY

Flexible redundancy offers security on multi-level applications, not only for the lighting.

PLUG AND PLAY COMMISSIONING

This control system is easy to install and configure. The tunnel lighting study can be directly imported into the ATS 4 control system. This unique feature, in combination with the auto-addressing of the Lumgates, leads to an extremely short commissioning time once the fixtures have been installed.

The ATS 4 benefits from a complete set of toolless smart cables and connectors, allowing installers to speed up cabling and save valuable time on-site

INTERACTION WITH THIRD PARTY SYSTEMS

Every command or signal sent to or coming from a tunnel component (emergency exit, smoke extraction system, traffic management system...) can be used to trigger a responsive lighting scenario. All of the tunnel equipment can be controlled through the same bus command.

MAXIMISED SAFETY

The system enables the easy set-up of emergency and disaster management scenarios.

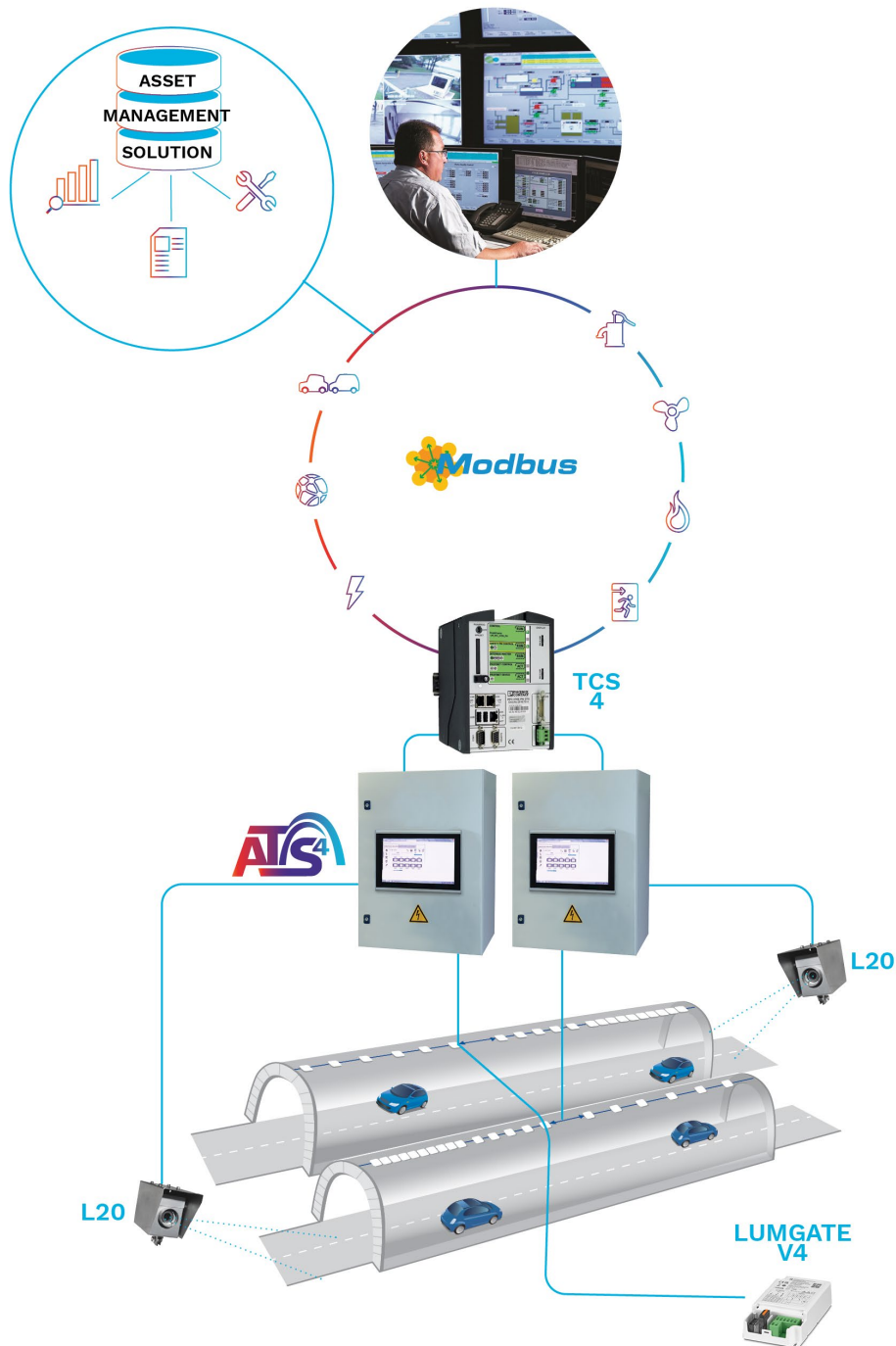

GENERAL INFORMATION

Recommended installation height	6m to 45m 20' to 148'
Circle Light label	Score ≥90 - The product fully meets circular economy requirements
CE mark	Yes
CB mark	Yes
ENEC certified	Yes
ENEC+ certified	Yes
UL certified	Yes
ROHS compliant	Yes
French law of December 27th 2018 - Compliant with application type(s)	a, b, c, d, e, f, g
RCM mark	Yes
Testing standard	LM 79-08 (all measurements in ISO17025 accredited laboratory)

HOUSING AND FINISH

Housing	Aluminium
Optic	Aluminium reflector PMMA Silicon
Protector	Tempered glass Frosted glass Polycarbonate
Housing finish	Polyester powder coating Standard polyester powder coating (C2-C3 according to the ISO 9223-2012 standard) Optional "seaside" polyester powder coating (C4 according to the ISO 9223-2012 standard) Optional "seafront" polyester powder coating with anodisation (C5-CX according to the ISO 9223-2012 standard)
Standard colour(s)	AKZO grey 900 sanded
Tightness level	IP 66
Impact resistance	IK 08, IK 10
Vibration test	Compliant with ANSI 1.5G and 3G and modified IEC 68-2-6 (0.5G)
Access for maintenance	Tool-less access to gear compartment
Safety compliance against ball throwing	DIN18 032-3:1997-04 according to EN 13 964 Annex D

· Any other RAL or AKZO colour upon request

OPERATING CONDITIONS

Operating temperature range (Ta)	-30°C up to +55°C / -22° F up to 131°F
----------------------------------	----------------------------------------

· Depending on the luminaire configuration. For more details, please contact us.

ELECTRICAL INFORMATION

Electrical class	Class 1 US, Class I EU, Class II EU
Nominal voltage	120-277V – 50-60Hz 220-240V – 50-60Hz 347-480V – 50-60Hz
Surge protection options (kV)	10 20
Control protocol(s)	1-10V, DALI, DMX-RDM
Control options	Lumgate, Custom dimming profile, Remote management
Socket	NEMA 7-pin (optional)
Associated control system(s)	Schröder EXEDRA Advanced Tunnel System 4 (ATS 4) Advanced Tunnel System 4 DALI (ATS 4 DALI) Nicolaudie Pharos

· Electrical information given for the gear box

OPTICAL INFORMATION

LED colour temperature	2700K (Warm White WW 727) 3000K (Warm White WW 730) 3000K (Warm White WW 830) 4000K (Neutral White NW 740) 4000K (Neutral White NW 940) 5700K (Cool White CW 757) 5700K (Cool White CW 857) 5700K (Cool White CW 957)
Colour rendering index (CRI)	>70 (Warm White WW 727) >70 (Warm White WW 730) >80 (Warm White WW 830) >70 (Neutral White NW 740) >90 (Neutral White NW 940) >70 (Cool White CW 757) >80 (Cool White CW 857) >90 (Cool White CW 957)
ULOR	0%
ULR	0%

· ULOR & ULR may be different according to the configuration. Please consult us.
· Other colour temperatures available as an option. Please contact us for further information

LIFETIME OF THE LEDS @ TQ 25°C

All configurations	100,000h - L85 100,000h - L95 (high-power LEDs)
--------------------	----------------------------------------------------

· Lifetime may be different according to the size/configurations. Please consult us.

DIMENSIONS AND MOUNTING

AxBxC (mm inch)	532x80x530 20.9x3.1x20.9
Weight (kg lbs)	12.0 26.4
Aerodynamic resistance (CxS)	0.17
Mounting possibilities	<ul style="list-style-type: none"> Hook(s) for suspension Side-entry slip-over – Ø76mm Post-top slip-over – Ø76mm Post-top slip-over – Ø76-108mm Bracket enabling adjustable inclination Surface mounting Direct mounting on ceiling

· For more information about mounting possibilities, please consult the installation sheet.

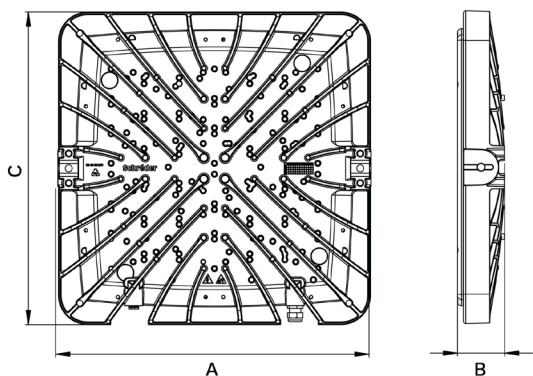



Number of LEDs	Luminaire output flux (lm)															Power consumption (W)		Luminaire efficacy (lm/W)	
	Warm White WW 727		Warm White WW 730		Warm White WW 830		Neutral White NW 740		Neutral White NW 940		Cool White CW 757		Cool White CW 857		Cool White CW 957				
	Min	Max	Min	Max	Min	Max	Min	Max	Min	Max	Min	Max	Min	Max	Min	Max	Min	Max	Up to
72	8300	24100	8600	30200	8100	31200	9300	34700	7800	29300	9300	34700	8800	25500	8100	30400	76	274	160
144	16700	48200	17300	58700	16200	60900	18600	67800	15700	57300	18600	67800	17700	51100	16300	59500	152	548	160

Tolerance on LED flux is ± 7% and on total luminaire power ± 5 %



Number of LEDs	Luminaire output flux (lm)						Power consumption (W)		Luminaire efficacy (lm/W)
	Warm White WW 730		Warm White WW 830		Neutral White NW 740				
	Min	Max	Min	Max	Min	Max	Min	Max	Up to
160	12300	60400	12000	58700	13400	65900	172	508	166
240	18500	74000	18000	72000	20200	80800	258	594	163

Tolerance on LED flux is ± 7% and on total luminaire power ± 5 %



Luminaire output flux (lm)																	Power consumption (W)		Luminaire efficacy (lm/W)
Warm White WW 727		Warm White WW 730		Warm White WW 830		Neutral White NW 740		Neutral White NW 940		Cool White CW 757		Cool White CW 857		Cool White CW 957					
Number of LEDs	Min	Max	Min	Max	Min	Max	Min	Max	Min	Max	Min	Max	Min	Max	Min	Max	Min	Max	Up to
72	8300	24100	8600	30200	8100	31200	9300	34700	7800	29300	9300	34700	8800	25500	8100	30400	76	274	160
144	16700	48200	17300	58700	16200	60900	18600	67800	15700	57300	18600	67800	17700	51100	16300	59500	152	548	160

Tolerance on LED flux is ± 7% and on total luminaire power ± 5 %



Luminaire output flux (lm)																	Power consumption (W)		Luminaire efficacy (lm/W)
Warm White WW 727		Warm White WW 730		Warm White WW 830		Neutral White NW 740		Neutral White NW 940		Cool White CW 757		Cool White CW 857		Cool White CW 957					
Number of LEDs	Min	Max	Min	Max	Min	Max	Min	Max	Min	Max	Min	Max	Min	Max	Min	Max	Min	Max	Up to
72	8300	24100	8600	30200	8100	31200	9300	34700	7800	29300	9300	34700	8800	25500	8100	30400	76	274	160
144	16700	48200	17300	58700	16200	60900	18600	67800	15700	57300	18600	67800	17700	51100	16300	59500	152	548	160

Tolerance on LED flux is ± 7% and on total luminaire power ± 5 %



Number of LEDs	Luminaire output flux (lm)						Power consumption (W)		Luminaire efficacy (lm/W)
	Warm White WW 730		Warm White WW 830		Neutral White NW 740		Min	Max	
	Min	Max	Min	Max	Min	Max			Up to
160	12300	60400	12000	58700	13400	65900	172	508	166
240	18500	74000	18000	72000	20200	80800	258	594	163

Tolerance on LED flux is ± 7% and on total luminaire power ± 5 %



Number of LEDs	Luminaire output flux (lm)															Power consumption (W)		Luminaire efficacy (lm/W)	
	Warm White WW 727		Warm White WW 730		Warm White WW 830		Neutral White NW 740		Neutral White NW 940		Cool White CW 757		Cool White CW 857		Cool White CW 957		Min		Max
	Min	Max	Min	Max	Min	Max	Min	Max	Min	Max	Min	Max	Min	Max	Min	Max		Up to	
72	8300	24100	8600	30200	8100	31200	9300	34700	7800	29300	9300	34700	8800	25500	8100	30400	76	274	160
144	16700	48200	17300	58700	16200	60900	18600	67800	15700	57300	18600	67800	17700	51100	16300	59500	152	548	160

Tolerance on LED flux is ± 7% and on total luminaire power ± 5 %